

ST 050 201 5660



Passt zu: TARA, META

- Wandrohr mit Schieber
- Rohrdurchmesser 18 mm
- Rosette Ø 55 mm
- Stichmaß 800 mm
- Metallbrauseschlauch 1750 mm mit integriertem Verdrehschutz
- Brauseschlauchanschluss 3/8"
- Dreifach bzw. fünffach verstellbar: COMPACT RAIN, COMPACT SOFT FLOW, COMPACT AQUAPRESSURE FLOW, Durchfluss max. 15 l/min (bei 3 Bar)
- Funktion ab: 7 l/min
- Brausekopf Ø 100 mm

	Chrom	ST 050 201 5660-00
	Platin gebürstet	ST 050 201 5660-06
	Platin	ST 050 201 5660-08
	Dark Chrome	ST 050 201 5660-19
	Light Gold	ST 050 201 5660-26
	Light Gold gebürstet	ST 050 201 5660-27
	Messing gebürstet (23kt Gold)	ST 050 201 5660-28
	Schwarz matt	ST 050 201 5660-33
	Bronze gebürstet	ST 050 201 5660-42
	Champagne gebürstet (22kt Gold)	ST 050 201 5660-46
	Champagne (22kt Gold)	ST 050 201 5660-47
	Chrom gebürstet	ST 050 201 5660-93
	Dark Platinum gebürstet	ST 050 201 5660-99

Einzelkomponenten dieses Sets

Für dieses Set benötigen Sie folgende Komponenten



1x 26 413 625-00



1x 28 018 979-00











ST 050 201 5660



Passt zu: TARA, META

- Wandrohr mit Schieber
- Rohrdurchmesser 18 mm
- Rosette Ø 55 mm
- Stichmaß 800 mm
- Metallbrauseschlauch 1750 mm mit integriertem Verdrehschutz
- Brauseschlauchanschluss 3/8"

Dieser Artikel enthält keine Handbrause!

	Chrom	26 413 625-00
	Platin gebürstet	26 413 625-06
	Platin	26 413 625-08
	Dark Chrome	26 413 625-19
	Light Gold	26 413 625-26
	Light Gold gebürstet	26 413 625-27
	Messing gebürstet (23kt Gold)	26 413 625-28
	Schwarz matt	26 413 625-33
	Bronze gebürstet	26 413 625-42
	Champagne gebürstet (22kt Gold)	26 413 625-46
	Champagne (22kt Gold)	26 413 625-47
	Chrom gebürstet	26 413 625-93
	Dark Platinum gebürstet	26 413 625-99

Empfohlenes Zubehör

	UP-Wandwinkel - •Max. Einbautiefe 163 mm •Min. Einbautiefe 90 mm	35 085 970 90
---	---	---------------

Benötigtes Zubehör

	Handbrause - Chrom	28 016 979-00
---	---------------------------	---------------

Benötigtes Zubehör

	Handbrause FlowReduce - Chrom	28 016 979-00 0010
---	--------------------------------------	-----------------------

Benötigtes Zubehör

	Handbrause FlowReduce - Chrom	28 012 979-00 0010
---	--------------------------------------	-----------------------

Benötigtes Zubehör

	Handbrause FlowReduce - Chrom	28 018 979-00 0010
---	--------------------------------------	-----------------------

Empfohlenes Zubehör

	Wandanschlussbogen - Chrom	28 450 625-00
---	-----------------------------------	---------------

Benötigtes Zubehör

	Handbrause - Chrom	28 012 979-00
---	---------------------------	---------------

Benötigtes Zubehör

	Handbrause - Chrom	28 017 979-00
---	---------------------------	---------------

Benötigtes Zubehör

	Handbrause - Chrom	28 018 979-00
---	---------------------------	---------------

ST 050 201 5660

mm [inches]

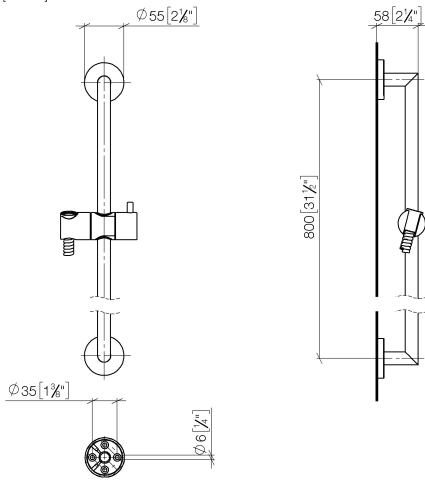

Zertifikate

WRAS_2009048. ACS_20 ACC LY 738. IAPMO_4976 (4).

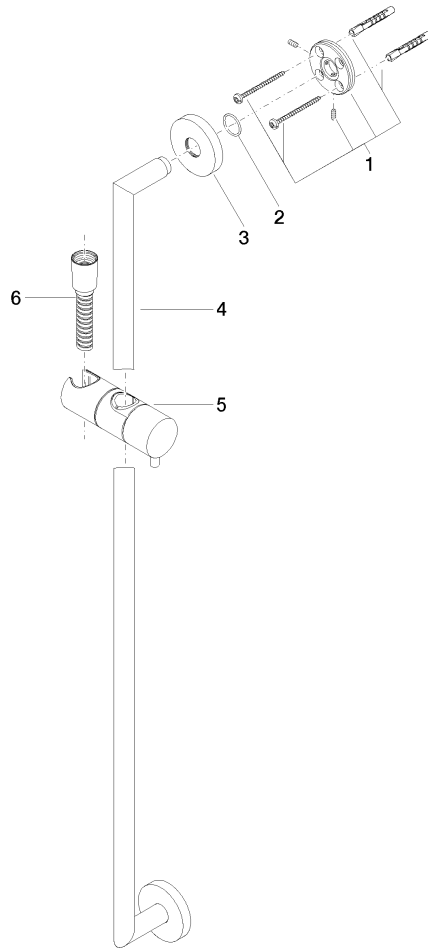

Ersatzteilstückliste

Nr.	Artikelnummer	Benennung	Verbaumenge	Lieferzeit
1	05 17 62 500 00 90	Befestigungssatz	2	2
2	90 14 10 032 00 90	Dichtung	2	2
3	08 27 62 500-00	Rosette	2	10
4	05 28 22 590 01-00	Stange	1	10
5	12 580 970-00	Schieber - Chrom	1	10
6	28 322 970-00	Metall-Brauseschlauch 1/2" x 3/8" x 1750 mm - Chrom	1	2





























ST 050 201 5660



- Dreifach bzw. fünffach verstellbar: COMPACT RAIN, COMPACT SOFT FLOW, COMPACT AQUAPRESSURE FLOW, Durchfluss max. 15 l/min (bei 3 Bar)
- mit Antikalk-System
- Brausekopf Ø 100 mm
- Anschluss 1/2"
- Funktion ab: 7 l/min

Eigensicher gegen Rückfließen.

Passt zu: IMO, LULU, MADISON, MEM, TARA, CL.1, LISSÉ, VAIA, META, CYO

	Chrom	28 018 979-00
	Chrom	28 018 979-00 0010
	Platin gebürstet	28 018 979-06
	Platin gebürstet	28 018 979-06 0010
	Platin	28 018 979-08
	Platin	28 018 979-08 0010
	Dark Brass matt	28 018 979-16 0010
	Dark Bronze matt	28 018 979-17 0010
	Dark Chrome	28 018 979-19
	Dark Chrome	28 018 979-19 0010
	Light Gold	28 018 979-26 0010
	Light Gold	28 018 979-26
	Light Gold gebürstet	28 018 979-27 0010
	Light Gold gebürstet	28 018 979-27
	Messing gebürstet (23kt Gold)	28 018 979-28
	Messing gebürstet (23kt Gold)	28 018 979-28 0010
	Schwarz matt	28 018 979-33
	Schwarz matt	28 018 979-33 0010
	Bronze gebürstet	28 018 979-42
	Bronze gebürstet	28 018 979-42 0010
	Champagne gebürstet (22kt Gold)	28 018 979-46
	Champagne gebürstet (22kt Gold)	28 018 979-46 0010
	Champagne (22kt Gold)	28 018 979-47
	Champagne (22kt Gold)	28 018 979-47 0010
	Chrom gebürstet	28 018 979-93
	Chrom gebürstet	28 018 979-93 0010
	Dark Platinum gebürstet	28 018 979-99
	Dark Platinum gebürstet	28 018 979-99 0010

ST 050 201 5660

mm [inches]

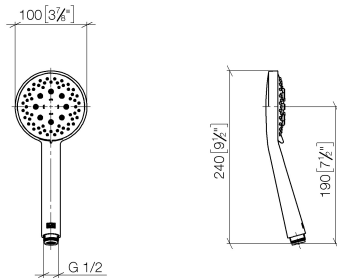

Durchflussdiagramm

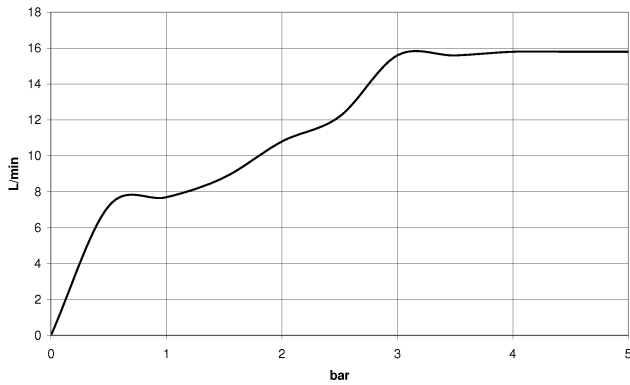

Zertifikate

LGA_29984.

DVGW_DW-
6517DN0129.

WRAS_2210003.

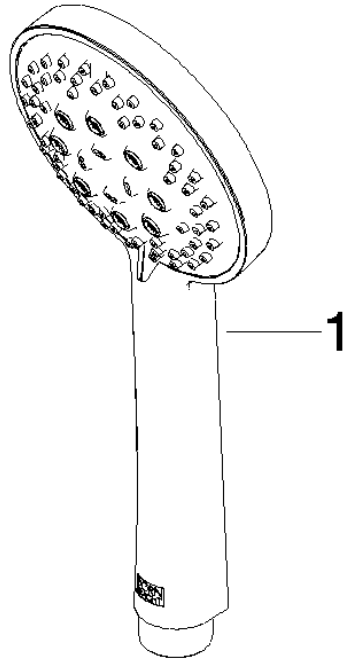

Ersatzteilstückliste

Nr.	Artikelnummer	Benennung	Verbaumenge	Lieferzeit
1	09 23 01 039 90	Sieb	1	2